

SUIT TAILORING OPTIONS

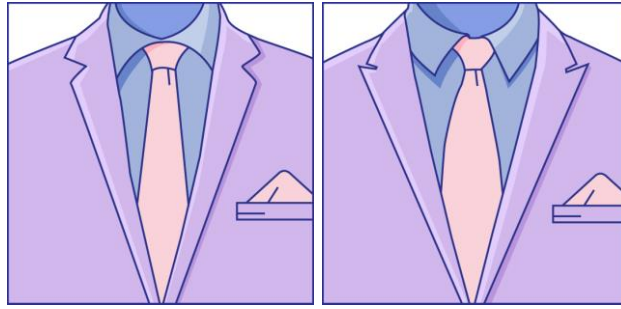

Slim notch

Slim peak



Standard notch

Standard peak

Shawl

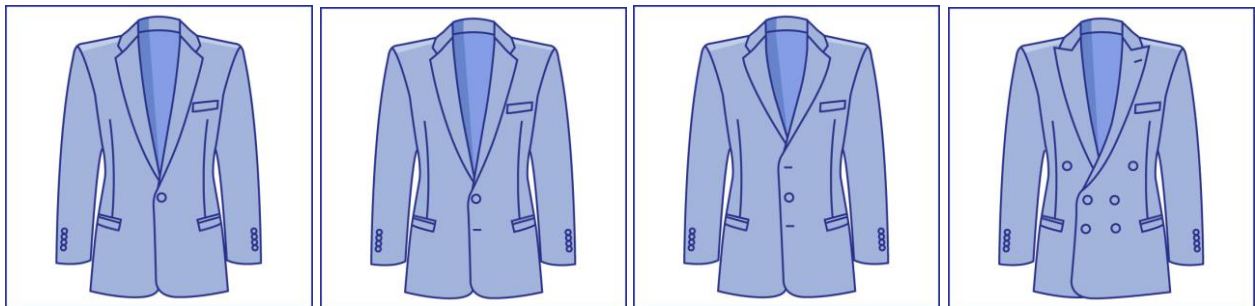

One button

Two buttons

Three buttons

Double breasted



Jetted pocket

Patch pocket

Flap pocket

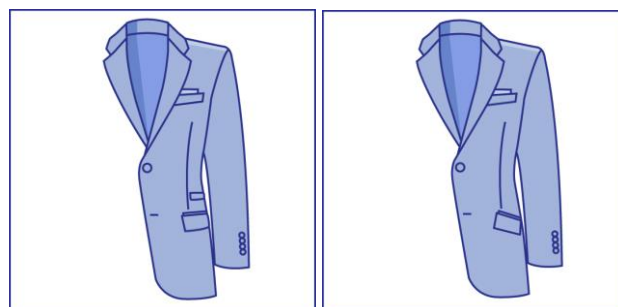

Ticket pocket

Angled pocket

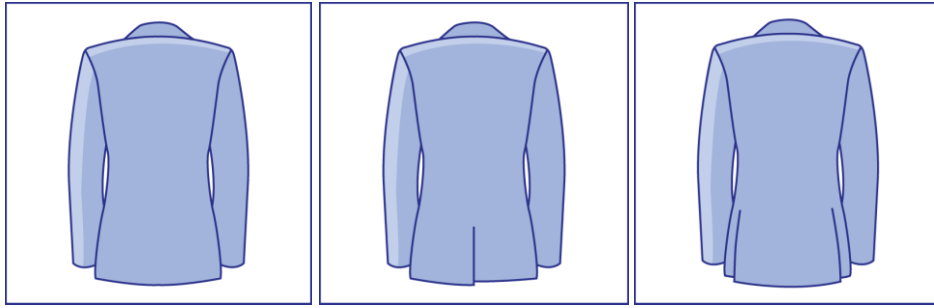

No vent

Single vent

Double vents

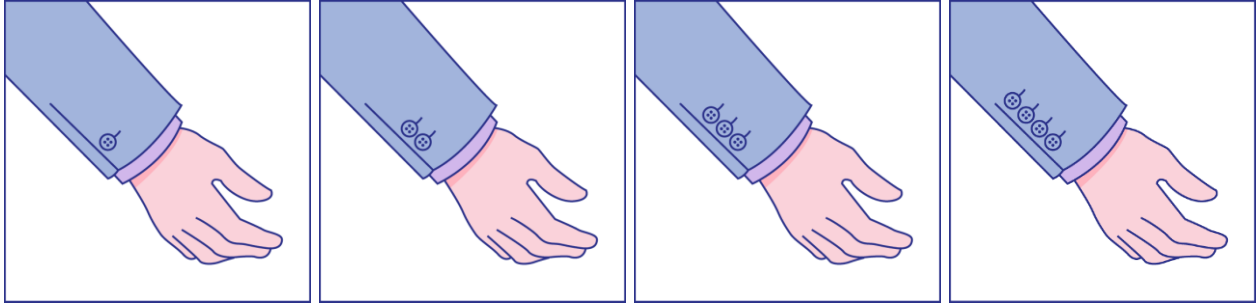

One button

Two buttons

Three buttons

Four buttons

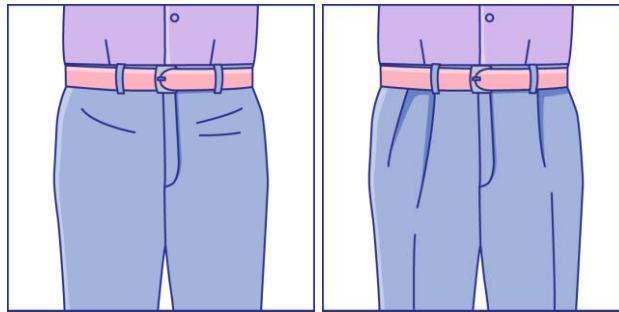

No pleat

Pleats

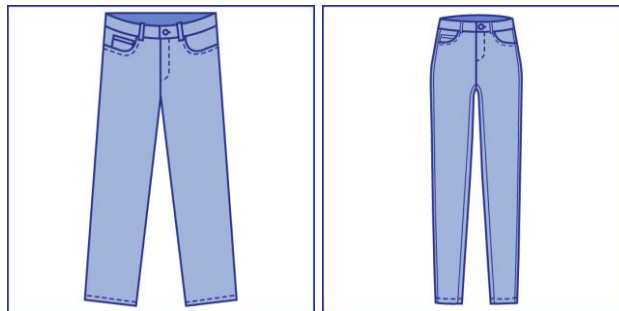

Straight legs

Tapered legs

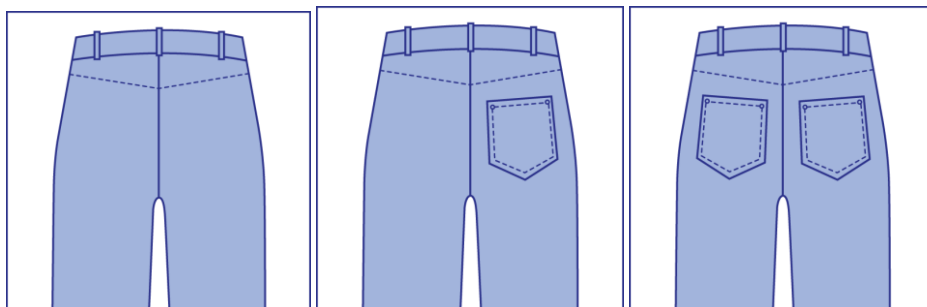

No pocket

One pocket

Two pockets

SHIRT TAILORING OPTIONS



Long sleeves

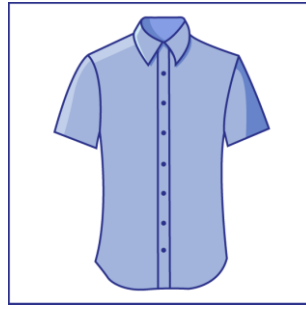

Short sleeves

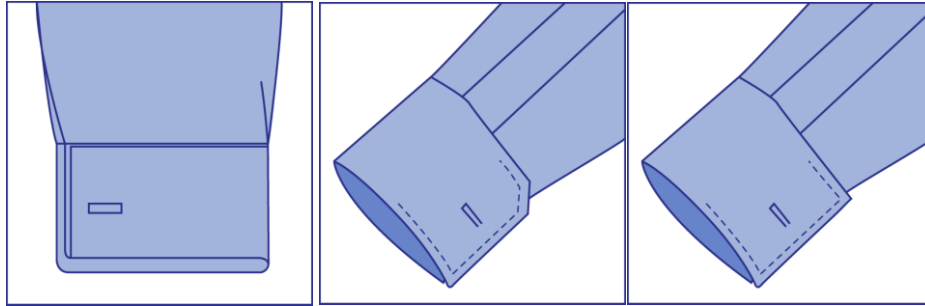

French cuff

Angled

Barrel

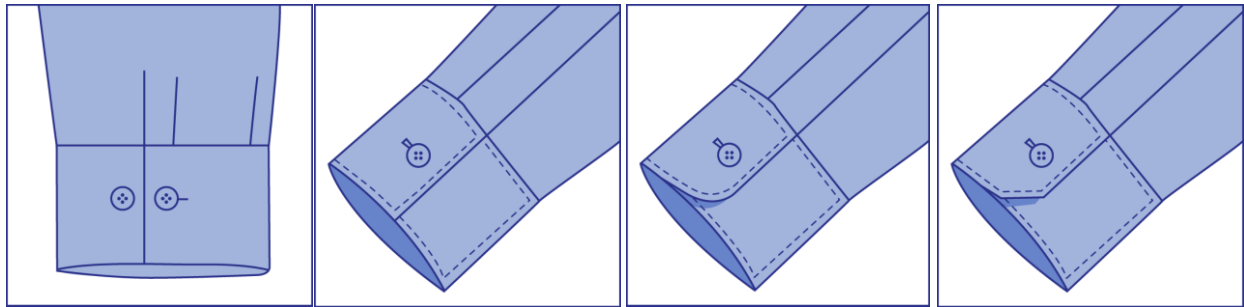

Button cuff

Barrel

Rounded

Angled

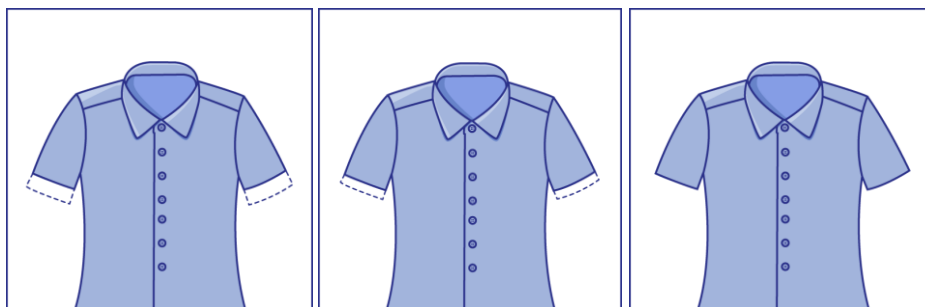

Long

Medium

Short

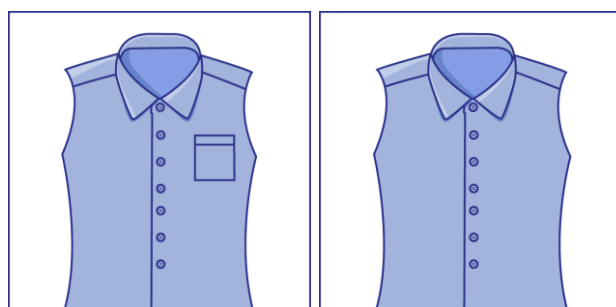

Chest pocket

No chest pocket

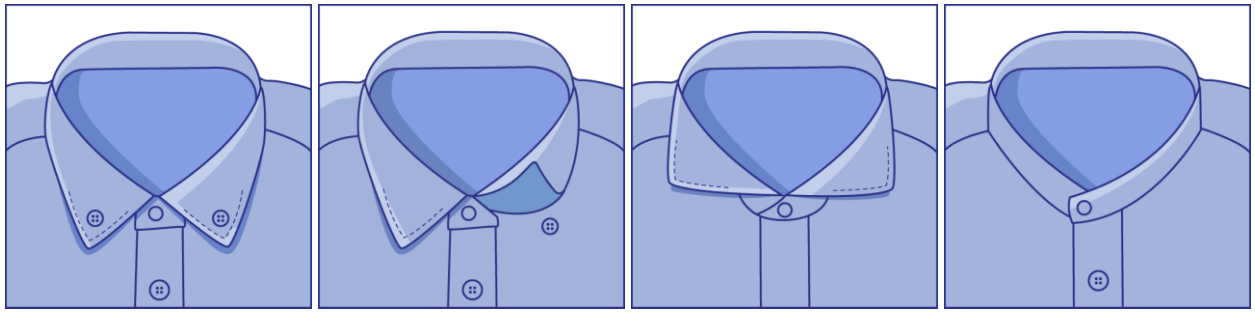

Button down

Concealed buttons

Cutaway

Mandarin

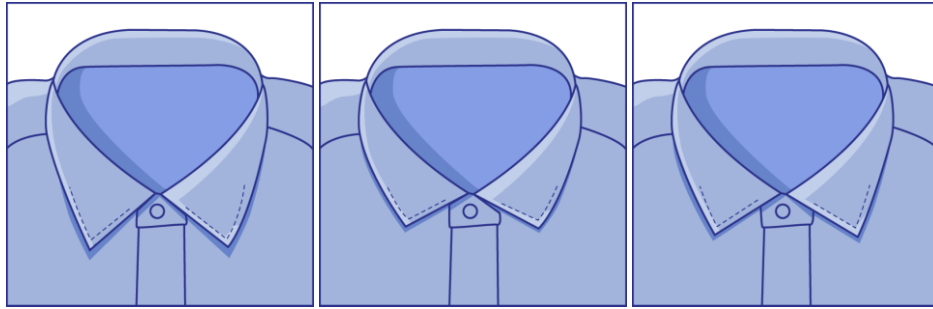

Pointed

Small spread

Spread

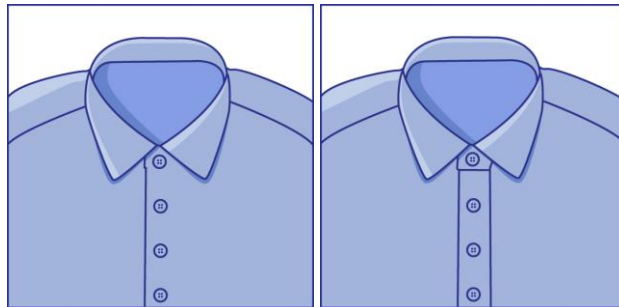

Plain placket

Straight placket

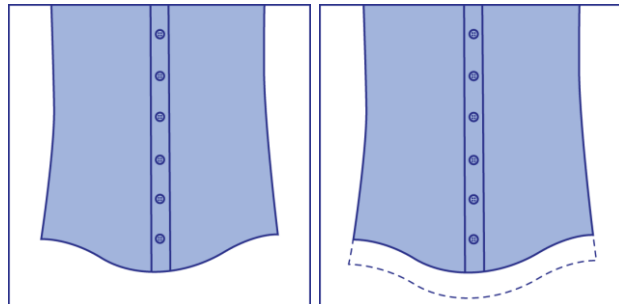

Tuck in bottom

Tuck out bottom

DEMO ONLY – DECIDED BY TAILOR



Darts (slim)

Plain (medium)

Side pleats (loose)